

THIS DRAWING IS THE EXCLUSIVE PROPERTY OF MARQUARDT. WITHOUT THEIR CONSENT IT MAY NOT BE REPRODUCED OR GIVEN TO THIRD PARTIES.

CONFIDENTIAL

VERTRAULICH

Alle Rechte bei Marquardt, auch fuer den Fall von Schutzrechtsanmeldungen. Jede Veruegungsbefugnis, wie Kopier- und Weitergaberecht, bei uns.

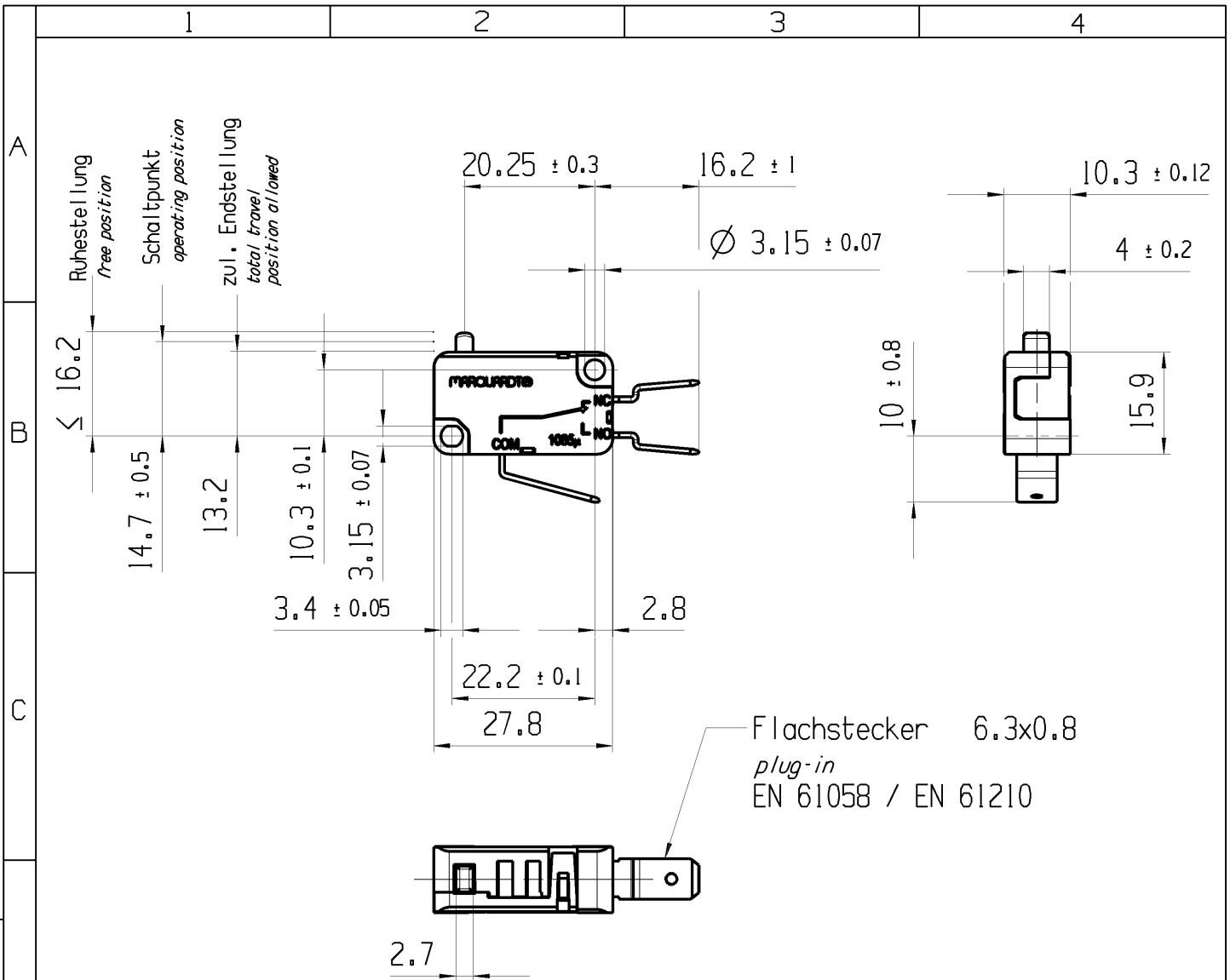

Flachstecker 6.3x0.8
plug-in
EN 61058 / EN 61210

Aufschrift
marking

MARQUARDT 
1085 μ T125

16141 /250 ~25E3 

16 A 125 AC 1/2 HP
16 A 250 AC 1/2 HP
R109 

Herstellort / -jahr / -woche
data code of manufacture:
place / year / week

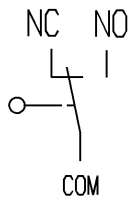

Wechsler 1-polig

single pole changeover

Schalt- Betaetigungskraft

actuating force

≤ 4.0 N

Rueckschaltkraft

release force

≥ 1.4 N

Differenzweg



movement differential

≤ 0.3 mm

Schutzart nach EN 60529

protection class

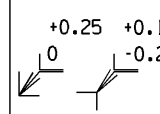
IP 40

| General tolerances | | | | | | Sheet 01 | | | Ident. | Document number | Index | |
|-----------------------------------|--|----------------|--|---------|-----------|---|---------------|--|---|-----------------|----------|---|
| All dimensions are in millimetres | Shape and location  0.1 | Angle ± 2 ° | Edge tolerance  +0.25 +0.1 0 -0.25 | 0-6 | ± 0.1 | ± 0.2 | Format DIN | Projection  | Scale 1 : 1 | K | 10850403 | g |
| | | | | >6-15 | ± 0.15 | ± 0.3 | | | | | | |
| | | | | >15-30 | ± 0.2 | ± 0.5 | | | | | | |
| | | | | >30-70 | ± 0.3 | | | | | | | |
| | | | | >70-120 | ± 0.4 | ± 10% | | | | | | |
| >120 | ± 0.8 | | | | | | | | | | | |
| g | 112677 | | 2017-11-28 | | TRIGUIK | | | | | | | |
| r | 63606 | | 2009-07-14 | | MTR | | | | | | | |
| e | 32889 | | 2001-12-04 | | VOR | | | | | | | |
| d | 24233 | | 1998-01-15 | | GC | | | | | | | |
| Index | ECN-No. | | Date (YYYY-MM-DD) | | Edited by | | | | | | | |
| | | | | | | System NX V10.0 | | | snap action switch | | | |
| | | | | | | Replacement of Zg.gl.Nr.v.07.09.1993 | | |  MARQUARDT | | | |